

SOLAR LIGHTING 2013

TEL: 01727 893 548

Formed in 2006, The Solar Centre has become one of the UK's leading new eco brands. Our constant focus on product innovation using the latest battery, LED and solar technology ensures year round reliability across our range. The Solar Centre supplies a large number of businesses and organisations of all sizes including high street retailers, e-retailers, government departments, local and county councils, housing associations, schools, colleges, universities, NGOs and charities.

Why work with us?

We are proud to offer a higher quality range of solar lighting products that are suitable for year-round use even in the UK. Our range includes decorative lights, party lights, security lighting and mains-equivalent utility lighting. We also offer a real time stock availability feed, 24hr delivery, technical expertise and training.

David, Geoff and Holly are committed to providing exceptional customer service over the phone, by email or in person. Call **01727 893 548** or email **trade@thesolarcentre.co.uk**

Meet the team



David Eaton
Partner



Geoff Gould
Sales Director



Holly Williams
Sales Administrator

We offer:

- Real time stock availability feed
- 24hr delivery
- Technical expertise and training
- Stock cleanse

Yearly analysis





Seasonal promotions

Customised shelf layout

Helping you sell:

- POS available
- Shelf header boards
- Free standing display units

SOLAR LIGHTING

			
WORKS IN WINTER	MAINS EQUIVALENT	NO MAINS	12 MONTH WARRANTY

Some of the brands we supply:



THEA SOLAR GARDEN SPOTLIGHT

Our [Thea Solar Garden Spotlight](#) will comfortably illuminate up to 15 metres making it one of the most powerful solar garden spotlights currently available. Ideal as an uplighter for large shrubs or small-to-medium trees and great for making a feature of any garden sculptures. The Thea Solar Garden Spotlight now comes with new fittings so it can be spike, wall or deck mounted.

- Charges by day, lights automatically at night
- Wall, fence, decking and spike fixtures included
- Highly adjustable solar panel and light head angle
- Simple to install, no assembly required
- 8 x super-bright white LEDs
- Toughened plastic construction
- On/off switch
- IP44 rated and fully weather resistant
- 12 month guarantee
- Designed for UK weather conditions



Product Code: SS7502



Dimensions

Light Body:	W: 125mm x D: 160mm
Light Height:	200mm, 450mm or 600mm
Boxed Weight:	0.87kg



WORKS
IN WINTER



NO MAINS



UP TO 12 HRS
RUNTIME



LIGHTS UP
TO 15M



SELENE SOLAR LANDSCAPE SPOTLIGHTS (SET OF 2)

The [Selene Solar Landscape Spotlights](#) can be positioned up to five metres away from their solar panel, enabling you to place solar lights in shaded areas where they wouldn't normally charge during the day. The Selene Solar Landscape Spotlights contain six super-bright LEDs in each light and can comfortably light up to a range of 25 metres.



- Charges by day, lights automatically at night
- 6 super-bright double sized LEDs in each light
- Adjustable solar panel and light angle
- Powerful 1.6W solar panel
- Will light for up to 10 hours once fully charged
- Fittings included for stake, deck, fence and wall mounting
- On/off switch
- IP44 rated and fully weather resistant
- 12 month guarantee
- Designed for UK weather conditions

Product Code: SS7570



Dimensions

Light Body:	H: 400mm x W: 90mm x D: 170mm
Solar Panel:	H: 100mm x W: 140mm
Boxed Weight:	1.72kg



WORKS
IN WINTER



NO MAINS



UP TO 10 HRS
RUNTIME



LIGHTS UP
TO 25M

HELIOS SOLAR SPOTLIGHT

Even after a succession of dull British days, the [Helios Solar Spot](#) turns itself on each night with unrivalled consistency. Few solar lights at this price point compete with the Helios Solar Spot Light's brightness, weather resistance and reliability.

- Charges by day, lights automatically at night
- Adjustable solar panel angle
- Simple to install, minimal assembly required (push fit connections)
- 4 x super-bright white LEDs
- Die-cast aluminium body with plastic spike
- On/off switch
- IP44 rated and fully weather resistant
- 12 month guarantee
- Designed for UK weather conditions

Dimensions

Light Body:	H: 400mm x W: 90mm x D: 170mm
Boxed Weight:	0.58kg



Product Code: SS7503

VORTEX SOLAR SHED LIGHT

The [Vortex Solar Shed Light](#) is a powerful mains-free lighting solution for sheds and outbuildings. The Vortex contains 36 LEDs, but has three settings so you can operate it using 12, 24 or all 36 LEDs. The Vortex comes with a powerful 1.5w solar panel making it fit for year-round use in the UK.

- Charges by day
- Will light for up to 8 hours once switched on after dark
- 36 super-bright white LEDs
- 4.8 metres of cable between light and solar panel
- 1.5W polycrystalline solar panel
- 1800mAh NiMH battery pack (supplied)
- On/off switch
- IP44 rated and fully weather resistant
- 12 month guarantee
- Designed for UK weather conditions

Lighting Modes

1. 36 LEDs on
2. 24 LEDs on
3. 12 LEDs on
4. Off



Dimensions

Solar Panel Base:	W: 180mm x D: 140mm
Solar Panel:	H: 190mm x W: 175mm
Light Unit Dimensions:	Diameter: 145mm x H: 25mm
Boxed Weight:	0.70kg

Product Code: SS7626

SOLAR PIR PORCH LIGHT

The [Solar PIR Porch Light](#) can be used for numerous applications both outside and in. It can be mounted outside in sheltered locations as a solar security light where it will illuminate for 30 seconds as soon as it detects motion. Alternatively the porch light can be installed inside a variety of outbuildings including garages, workshops, sheds, shelters, stables, tents and porches.

- Charges by day, lights automatically at night when motion is detected
- Highly portable solar PIR light
- Capacity for up to 8 hours light once fully charged
- Will light for 30 seconds once motion is detected
- 36 super-bright LEDs
- 0.6W polycrystalline solar panel
- Rechargeable batteries: 3 x AAA NiMH 750mAh
- PIR detection range 2m to 6.5m
- 360° PIR detection



- 4.8m of cable between solar panel and light
- Simple and easy to install, no need for an electrician
- Batteries, screws, wall plugs, instructions and mounting bracket included
- IP44 rated and fully weather resistant
- 12 month guarantee
- Designed for UK weather conditions

Product Code: SS7526

Dimensions

Solar Panel Base: **W: 130mm x D: 100mm**

Solar Panel: **W: 175mm x H: 130mm**

Light Unit
Dimensions: **Diameter: 145mm x H: 40mm**

Boxed Weight: **0.54kg**

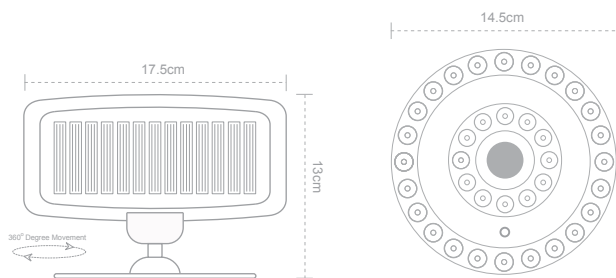

**WORKS
IN WINTER**



NO MAINS



**250 TRIGGERS
PER NIGHT**



**70 WATT
EQUIVALENT**



EVO15 SOLAR PIR UTILITY LIGHT

The **Evo15 Solar PIR Utility Light** is a real game changer for the budget end of the solar security light market. It can be used outside as a solar security light or inside as a solar shed light. The Solar PIR Utility Light will activate for 25 seconds when motion is detected.

- Charges by day, lights automatically at night when motion is detected
- Up to 250 activations per night
- Will light for 25 seconds once motion is detected
- 15 super-bright 9000mcd LEDs
- 0.6W polycrystalline solar panel
- Rechargeable batteries: 3 x AAA NiMH 750mAh (included)
- PIR detection range 2m to 6.5m
- 4.8m of cable between solar panel and light
- No need for an electrician
- IP44 rated and fully weather resistant



- No operating costs
- No running costs
- Batteries, screws, wall plugs, instructions and mounting bracket included
- 12 month guarantee
- Designed for UK weather conditions

Product Code: SS7516

Dimensions

Solar Panel Base: **W: 130mm x D: 100mm**

Solar Panel: **W: 175mm x H: 130mm**

Light Unit
Dimensions: **H: 160mm x W: 130mm x D: 90mm**

Boxed Weight: **0.48kg**



WORKS
IN WINTER



NO MAINS



250 TRIGGERS
PER NIGHT



50 WATT
EQUIVALENT

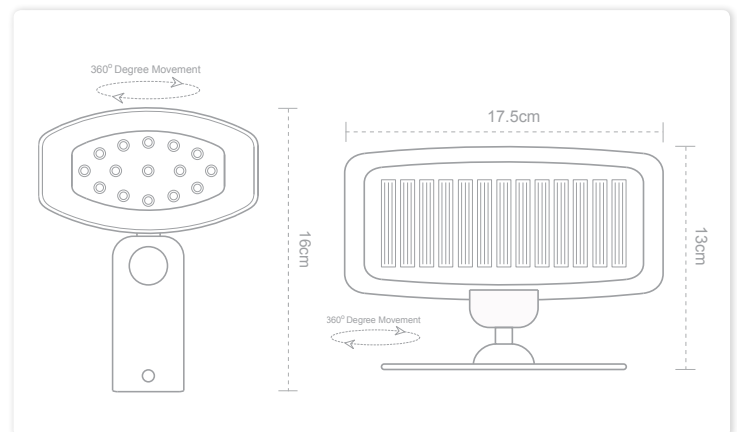

EVO36 & EVO56 SOLAR SECURITY LIGHTS

The **Evo36** (36 LED bulbs) & **Evo56** (56 LED bulbs) next generation solar security lights can be placed anywhere outside allowing you the freedom to provide security lighting to any area without needing to call an electrician to install a costly outdoor mains power supply. These mains-powered equivalent solar security lights are equipped with powerful solar panels and high capacity batteries to ensure consistent year-round performance.

- Charges by day, lights automatically at night when motion is detected
- 2 to 12 metre PIR detection range
- Lights turn off after motion stops (adjustable 4 to 30 seconds)
- Fully adjustable light and sensor position
- 5m of solar panel cable
- Adjustable sensitivity
- Adjustable lux setting
- On/off switch
- 3m solar panel extension cables available separately
- IP44 rated and fully weather resistant
- 12 month guarantee
- Designed for UK weather conditions



Evo36 Product Code: SS7551
Evo56 Product Code: SS7552

Dimensions

Light Body:	H: 200mm x W: 140mm x D: 13mm
Solar Panel:	H: 190mm x W: 175mm
Boxed Weight:	1.3kg

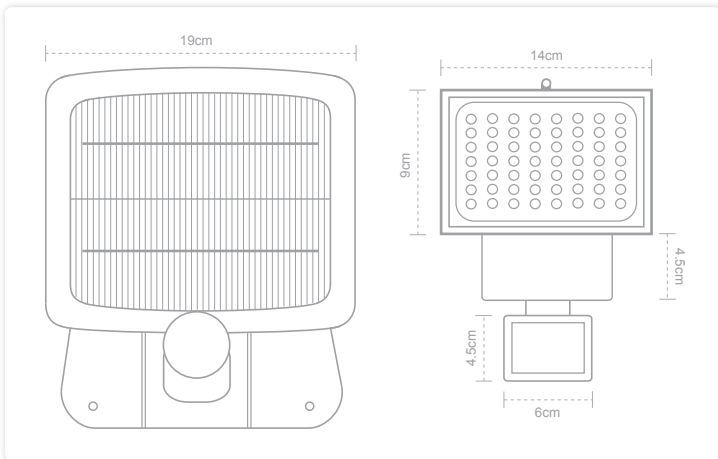

WORKS
IN WINTER



NO MAINS



500 TRIGGERS
PER NIGHT



UPTO 150 WATT
EQUIVALENT

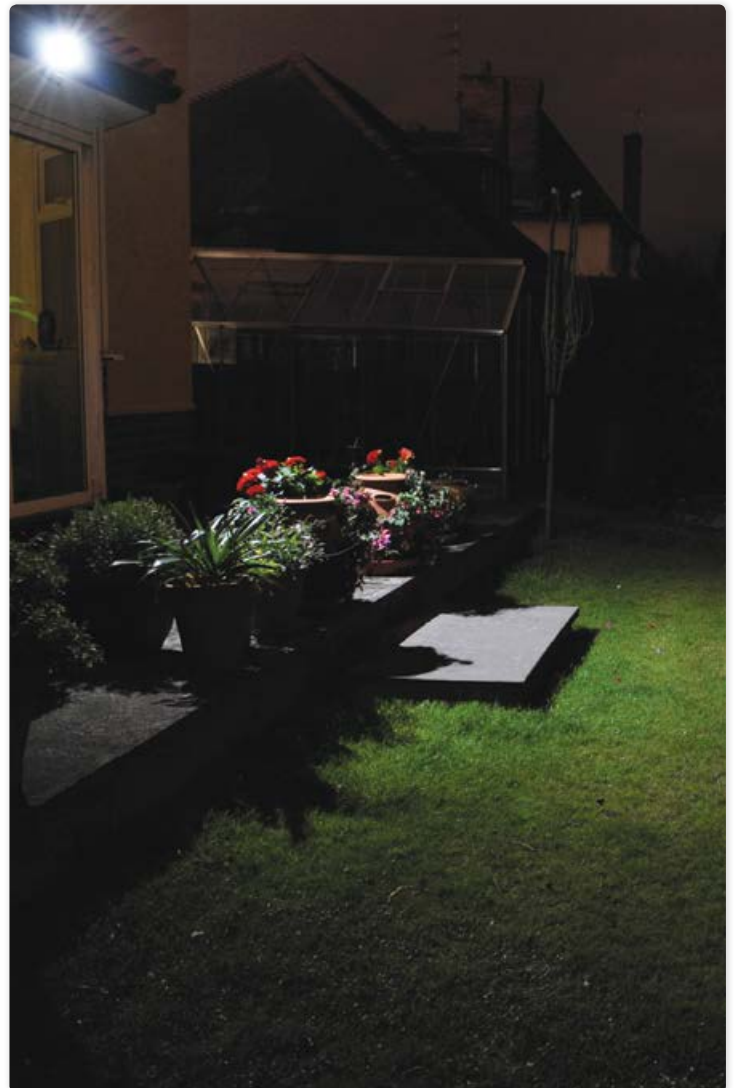

Customer photograph of an Evo56 in action

EVO36 & EVO56 BOOSTER SOLAR PANEL

The [Evo Booster Solar Panel](#) adds 2.5W of power to the existing solar panel that comes with the Evo36 or Evo56. Once installed the Evo Booster Solar Panel will double the amount of charge your Evo receives during each day making it ideal for consistently heavy winter usage or year round commercial applications.



Product Code: SS7546



Customer photograph of an Evo56 in action

Specifications	Evo 36	Evo 56
No. of LEDs	36	56
Solar Panel	2W	2.5W
Battery	2000mAh	2500mAh
Lighting Distance	20 – 30m	30 – 40m

Dimensions	
Booster Panel:	H: 190mm x W: 175mm
Boxed Weight:	0.5kg

PAVERLIGHT SOLAR BRICK LIGHTS

The **Paverlights** have been designed to fulfil the growing demand for affordable standard brick sized solar lights. The Paverlights offer unparalleled performance and build quality for their price and will provide years of hassle-free enjoyment.

- Standard block paving brick size
- Able to withstand the weight of a car
- Non-slip surface
- 3 white LED bulbs per light
- Up to 12 hours run time
- IP67 water proofing
- Designed for UK weather conditions



GIMA Outdoor Leisure
Finalist 2012
DIY WEEK Garden Accessory of the Year
Silver 2012



Dimensions

Light Body:	H: 55mm x W: 97mm x D: 197mm
Boxed Weight:	0.90kg

Product Code: SS9787

SOLAR DRIVEWAY LIGHT

The highly durable **Solar Driveway Light** contains 5 ultra high efficiency LEDs that give off a pleasing glow that is totally unique to this product. Once recessed, the Solar Driveway Light can comfortably withstand loads of up to 2 tonnes making it ideal for any driveway.

- 5 white super-bright LEDs
- Charges by day, lights automatically at night
- 2 tonnes surface load capacity
- IP44 rated and fully weather resistant
- 12 month guarantee
- Designed for UK weather conditions

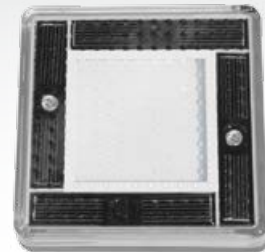

Dimensions

Light Body:	H: 45mm x W: 145mm x D: 145mm
Boxed Weight:	0.63kg

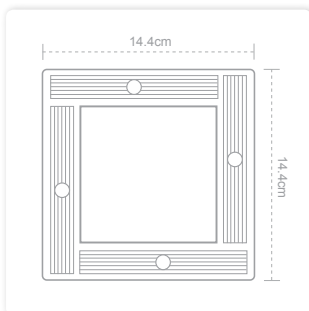

Product Code: SS7537

SOLAR ROUND DECKING LIGHT

The [Solar Round Decking Light's](#) robust stainless steel build makes it perfect for demanding locations. The light uses only the best quality solar panels and batteries enabling it to operate even after a succession of dull winter days.

- Panel type: Monocrystalline
- Panel wattage: 0.3w
- No. of LEDs: 1
- LED bulb colour: White
- Battery capacity: 1200mAh
- Battery type: NiMH
- Replaceable batteries: Yes
- Mounting options: deck, driveway, pathway, patio, wall
- Max. operating hours: 8 hours
- Material: Stainless steel housing with glass cover
- On/off switch
- Fully weather resistant
- 12 month guarantee
- Designed for UK weather conditions

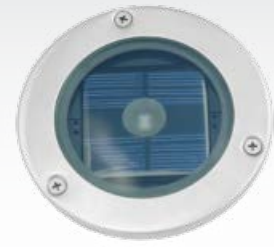

Dimensions

Light Body: Diameter: 120mm x H: 35mm

Recess Dimensions: Diameter: 97mm x H: 30mm

Boxed Weight: 0.45kg



Product Code: SS7542

SOLAR SQUARE DECKING LIGHT

This elegant stainless steel decking light is finished to the very highest standards and emits a beautiful glow after dark. [The Solar Square Decking Light](#) contains a 0.3W solar panel coupled with 1200mAh batteries guaranteeing year-round reliability in the UK.

- Panel type: Monocrystalline
- Panel wattage: 0.3w
- No. of LEDs: 1
- LED bulb colour: White
- Battery capacity: 1200mAh
- Battery type: NiMH
- Replaceable batteries: Yes
- Mounting options: deck, driveway, pathway, patio, wall
- Max. operating hours: 8 hours
- Material: Stainless steel housing with glass cover
- On/off switch
- IP44 rated and fully weather resistant
- 12 month guarantee
- Designed for UK weather conditions

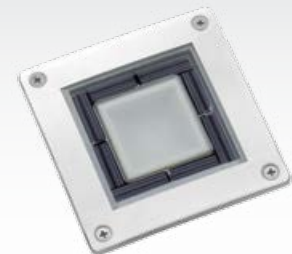

Dimensions

Light Body: H: 30mm x W: 120mm x D: 120mm

Recess Dimensions: H: 25mm x W: 92mm x D: 92mm

Boxed Weight: 0.4kg



Product Code: SS7543

SILVERLIGHT RANGE™

The [Silverlight Range](#) is designed to meet the growing demand for stylish and contemporary mains-free wall and post lighting. The Silverlight range is made from high quality stainless steel and is designed to work reliably year- round in the UK.

The Silverlight standard defines the idea of effortless superior refinement. Products worthy of this badge are manufactured using only the very best stainless steel and exceptional monocrystalline solar panels. This combination delivers unrivalled lighting performance with build quality that is second to none.



CANTERBURY SOLAR WALL LIGHT

The [Canterbury Solar Wall Lights](#) modern cylindrical design makes it ideal for contemporary settings where mains free lighting is preferred. These decorative solar wall lights will charge by day and light automatically after dark.

- Charges by day, lights automatically at night
- Stainless steel construction
- Up to 10 hours run time
- 1 x super-bright white SMD bulb
- Monocrystalline solar panel
- 2 x 600mAh AA NiMH rechargeable batteries
- On/off switch
- IP44 rated and fully weather resistant
- 12 month guarantee
- Designed for UK weather conditions



Dimensions

Light Diameter:	78mm
Light Width:	145mm
Height:	325mm
Boxed Weight:	0.75kg

SILVERLIGHT
RANGE™

Product Code: SS9056

LONDON SOLAR POST LIGHTS (SET OF 2)

The [London Solar Post Lights](#) are made from high quality stainless steel and are ideal for lining pathways and borders.

- Charges by day, lights automatically at night
- Stainless steel construction
- Monocrystalline solar panel
- Up to 8 hours run time
- 1 x super-bright white SMD bulb per light
- 2 x 600mAh AA NiMH rechargeable batteries per light
- On/off switch
- IP44 rated and fully weather resistant
- 12 month guarantee
- Designed for UK weather conditions



Dimensions

Light Diameter:	78mm
Light Height:	400mm
Spike Height:	180mm
Boxed Weight:	1.2kg

SILVERLIGHT
RANGE™

Product Code: SS9058

DURHAM SOLAR POST LIGHT

The [Durham Solar Post Light](#) is an 80cm tall solar powered post light made from high-quality stainless steel. Its contemporary yet elegant design makes it ideal for marking entrances, lining paths and lighting driveways.

- Charges by day, lights automatically at night
- Exclusive stainless steel construction
- Up to 10 hours run time
- Turns on and off automatically
- On/off switch to override this if required
- 1 x super-bright white SMD bulb per light
- Monocrystalline solar panel
- 2 x 600mAh NiMH rechargeable batteries (included)
- IP44 waterproofing



Dimensions

Light Diameter:	75mm
Diameter at base:	115mm
Light Height:	800mm
Boxed Weight:	1.5kg

SILVERLIGHT
RANGE™

Product Code: SS9071

EYE SOLAR SECURITY LIGHT

The **Eye Solar Security Light** offers mains equivalent brightness and is our most innovative security light design yet. The light head is just 4cm thick and can be rotated 170 degrees left or right and tilted more than 180 degrees up or down. The Eye also benefits from our new state-of-the-art digital motion sensor which offers greater accuracy and waterproofing.

- Innovative swivel mount design offers flexibility of positioning
- Digital motion sensor
- Sensor can be mounted up to 5m from light
- Solar panel can be mounted up to 5m from light
- IP56 rated and fully weather resistant
- Saves costly mains installation
- 12 month guarantee
- Designed for UK weather conditions



Dimensions

Light Unit: H: 210mm x W: 170mm x D: 40mm

Solar Panel: H: 190mm x W: 160mm x D: 15mm

Boxed Weight: 1.5kg

Product Code: SS9833

EVERJET SOLAR FOUNTAIN

Easily add a solar fountain to your pond or water feature without the need for mains wiring with the new **Everjet Solar Fountain**. The Everjet Solar Fountain is designed to work mainly in direct sunlight, but its replaceable backup batteries can keep it running for up to 7 hours in cloudy conditions or after dark.

- Mains-free solar powered fountain for ponds or water features.
- Works constantly in sunlight
- Backup AA batteries enable fountain to run without sun
- Can operate without sun for 7 hours once fully charged
- Uses AA rechargeable batteries (included)
- Adjustable height of the water jet up to 1m
- Float included
- 4 different fountain tips included.
- Designed to work in the UK



Dimensions

Solar Panel: H: 230mm x W: 225mm x D: 165mm

Boxed Weight: 1.1kg

Product Code: SS9827

EVERJET
SOLAR FOUNTAIN™

KENSINGTON SOLAR WALL LIGHT

The **Kensington Solar Wall Light** has been designed in the UK to work in the UK and redefines what can be expected from a solar light in British wintertime. Even after a succession of dull winter days the Kensington can deliver light until dawn with unrivalled consistency.

- All night run time
- Fully weather resistant
- Standard fascia brick size
- Five minute installation
- Easily mounted on walls or fences
- Saves costly mains installation
- IP64 rated and fully weather resistant
- 12 month guarantee
- Designed for UK weather conditions

Kensington 
solar wall light

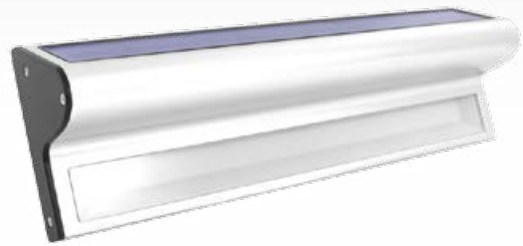

Dimensions

Light:	H: 65mm x W: 215mm x D: 38mm
Boxed Weight:	0.7kg

Product Code: SS9833

CURVE SOLAR MOTION LIGHT

The **Curve Solar Motion Light** is designed to guide you to your door after dark using only the power of the sun. After dark the Curve emits a constant gentle glow until motion is detected where the full force of the Curve's 16 natural white LED bulbs illuminate before turning off automatically 30 seconds after motion stops.

- 16 natural white LED bulbs
- On/off switch
- Five minute installation
- Mount it to any wall or fence
- Saves costly mains installation
- IP64 rated and fully weather resistant
- 12 month guarantee
- Designed for UK weather conditions



curve solar motion light

Dimensions

Light:	H: 76mm x W: 92mm x D: 130mm
Boxed Weight:	0.75kg

TOTALLY DIY
Best Security Product - Silver 2013

Product Code: SS9826

EVERBRIGHT SOLAR FAIRY LIGHTS - USB CHARGEABLE

Solar Fairy Lights are perfect for anyone looking to put up fairy lights outside without using mains power. [Everbrights](#) are now also USB chargeable which means you can use them inside your home as well as outside. USB also gives you the option to fully charge your lights in time for a party or special occasion if the weather has let you down.

- Charges by day, lights automatically at night
- USB mains chargeable
- Simple to install
- Self contained, can be positioned anywhere!
- Turns on automatically at dusk for 8 hours
- 8 lighting modes
- No operating costs
- Environmentally friendly
- Different colours and lengths available
- IP44 rated and fully weather resistant
- 12 month guarantee
- Designed for UK weather conditions



EVERBRIGHT

solar fairy lights™

Product Codes:

[White 50 LEDs - EBW50](#)

[White 100 LEDs - EBW100](#)

[White 300 LEDs - EBW300](#)

[Warm White 100 LEDs - EWW100](#)

[Warm White 300 LEDs - EWW300](#)

[Blue 100 LEDs - EBB100](#)

[Blue 300 LEDs - EBB300](#)

[Multi Coloured 100s - EBM100](#)

[Multi Coloured 300s - EBM300](#)



Dimensions

Colours: **White, Blue, Yellow and Multicoloured**

Lengths: **50 LED (5m), 100 LED (10m), 300 LED (28m)**



MAINS EQUIVALENT



WORKS IN WINTER



DUAL POWER



UMB-SYS PROTECTION

Everbrights in the press

THE INDEPENDENT

["Transform your yard into a glittering grotto"](#)
- 10 Best Garden Lamps

SUNDAY MIRROR

Voted 9/10 in the Sunday Mirror
- Garden Solar Gadgets Review

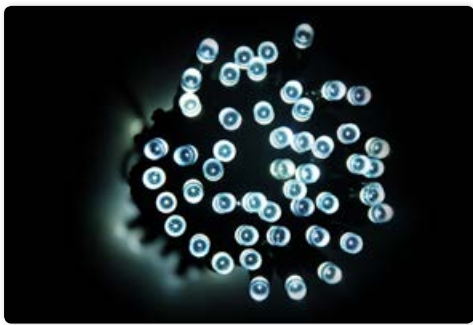

EVERBRIGHT SOLAR PARTY LIGHTS - USB CHARGEABLE

Everbright Solar Party lights are a perfect way to decorate outdoor spaces for BBQs and parties in the summer or for that festive feel at Christmas.

- Charges by day, lights automatically at night
- Available in white and multicoloured
- 20 globes spaced 80cm apart
- USB mains chargeable
- 2 lighting modes (constant on, or flashing)
- IP44 rated and fully weather resistant
- 12 month guarantee
- Designed for UK weather conditions

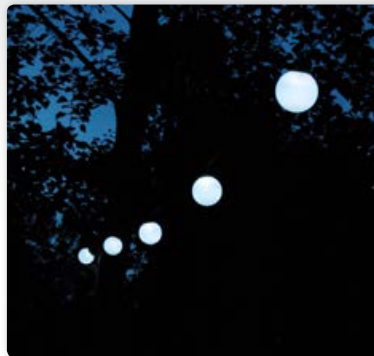

EVERBRIGHT
solar party lights™

Dimensions

Ball Diameter:	40mm
String Length:	16m
Boxed Weight:	0.9kg



[White Product Code: EBW20](#)
[Multicoloured Product Code: EBM20](#)

EVERBRIGHT SOLAR RATTAN LIGHTS

[Everbright Solar Rattan Lights](#) are a great way to decorate outdoor spaces for a BBQ or party in the summer or for festive occasions. The lights turn on and off automatically each night and come complete with 2 lighting modes.

- 20 rattan balls on a 16m string
- Can work for up to 10 hours once fully charged
- Charges by day, lights automatically at night
- USB mains chargeable
- 2 lighting modes (constant on, or flashing)



Dimensions

Ball Diameter:	50mm
String Length:	16m
Boxed Weight:	0.9kg

Product Code: SS9823

EVERBRIGHT SOLAR HESSIAN LIGHTS

[Everbright Solar Hessian Lights](#) are a great way to decorate outdoor spaces for a BBQ or party in the summer or for festive occasions. The lights turn on and off automatically each night and come complete with 2 lighting modes.

- 20 hessian balls on a 16m string
- Can work for up to 10 hours once fully charged
- Charges by day, lights automatically at night
- USB mains chargeable
- 2 lighting modes (constant on, or flashing)

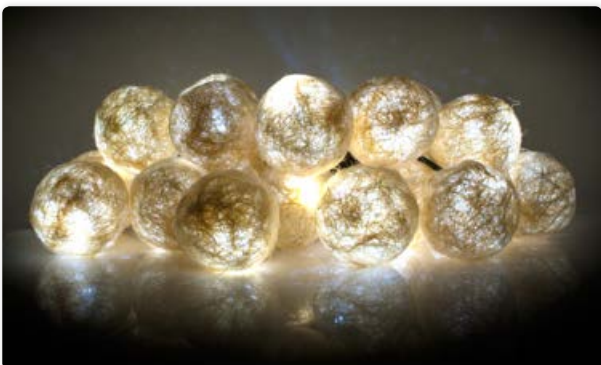

Dimensions

Ball Diameter:	50mm
String Length:	16m
Boxed Weight:	0.9kg

Product Code: SS9824

EVERBRIGHT SOLAR CHINESE LANTERN LIGHTS

Everbright Solar Chinese Lantern Lights are a great way to decorate outdoor spaces for a BBQ or party in the summer or for festive occasions. The lights turn on and off automatically each night and come complete with 2 lighting modes.

- 20 chinese lanterns on a 16m string
- Can work for up to 10 hours once fully charged
- Charges by day, lights automatically at night
- USB mains chargeable
- 2 lighting modes (constant on, or flashing)



Dimensions

Ball Diameter:	6.5mm
String Length:	16m
Boxed Weight:	0.9kg

Product Code: SS9825

BLINGSTRING SOLAR FAIRY LIGHTS

Blingstring Solar Fairy Lights represent great value for money by delivering brightness and reliability that was previously only available at twice the price! Available with 50 or 120 LED bulbs.

- Can work for up to 10 hours once fully charged
- Turn on automatically at night and turn off automatically at dawn
- On/off switch so you can turn them off whenever you want
- 2 lighting modes (constant on, or flashing)
- Wall mount and stake mount supplied
- Come supplied with standard AA rechargeable batteries (replaceable)

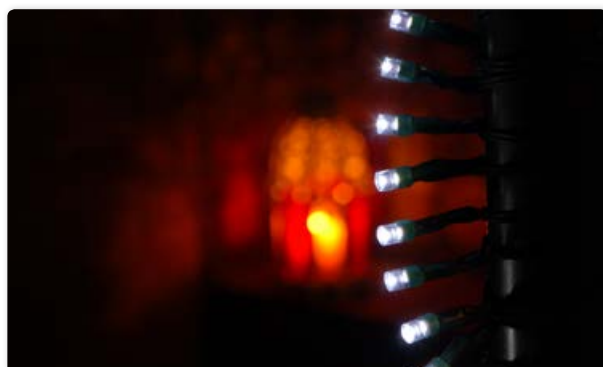

Dimensions

Size:	H: 250mm x W: 120mm x D: 120mm
Boxed Weight:	0.31kg (50 LEDs) 0.35kg (120 LEDs)

Product Code: [50 LEDs](#), SS9800 or [120 LEDs](#), SS9801

ASTRON SOLAR FLOODLIGHT

The [Astron Solar Floodlight](#) is a mains equivalent 40 LED solar floodlight which gives you up to 12 hours of light each night. With its 50m range remote control, the Astron has many applications including: general outdoor lighting, outdoor security lighting, indoor shed and outbuilding lighting, sign lighting, feature uplighter, portable work light and even emergency home backup lighting.

- Commercial grade solar floodlight
- Remote controlled (50 metre range)
- 40 bright natural white LEDs
- Can light for upto 12 hours once fully charged
- Glass lens
- 12 month warranty
- IP56 waterproofing and fully weather resistant
- Boxed Weight: 3.5kg
- Dual solar panel input
- 5m of solar panel cable
- Robust aluminium housing



Astron[™]
SOLAR FLOODLIGHT

Dimensions

Light Unit:	H: 215mm x W: 165mm x D: 60mm
Solar Panel:	H: 280mm x W: 335mm x D: 16mm
Boxed Weight:	4.5kg

Product Code: SS9798

ASTRON64 SOLAR SECURITY LIGHT

The award winning [Astron64](#) is the brightest, most reliable, most versatile and most waterproof solar security light we have ever made. The Astron64 can deliver an astonishing 100 activations of 1 minute once fully charged.

- Commercial grade solar security light
- Digital PIR with adjustable lux, time and sensitivity
- 64 superbright LEDs
- 2.5W solar panel
- IP56 Waterproofing
- PIR can be mounted between 20cm-120cm from light
- Solar panel can be mounted up to 5m away from light
- Works reliably in UK winter



Astron[™]
SOLAR FLOODLIGHT

Dimensions

Light Unit:	H: 215mm x W: 165mm x D: 60mm
Solar Panel:	H: 137mm x W: 190mm x D: 26mm
Boxed Weight:	2.5kg

Product Code: SS9813

Totally DIY Best Security Product
Gold 2013
DIY WEEK Security Product of the Year
Gold 2012

GEO SOLAR PANELS

Our Geo solar panel range are made using high quality silicon with anodized aluminium alloy frames and are guaranteed for 20 years. The Geo solar panels range from 5w to 50w making them ideal for a variety of applications from small lighting kits to larger off-grid power systems.

General Specifications:

- **Peak voltage:** 18v
- **Life span for each module:** 25 years
- **Open circuit voltage:** 21.6v
- **Encapsulation:** Sealed with low iron tempered glass
- **Connection box:** Waterproof junction box
- **Solar Panel Type:** Polycrystalline
- **Warranty:** 20 Years
- **Frame:** Anodized aluminium alloy frame



5W Solar Panel

[5W Solar Panel](#) ideal for charging 35ah 12v or larger batteries and providing solar energy for small lighting systems.

Peak output: 5W

Size: H: 250mm x W: 200mm



10W Solar Panel

[10W solar panel](#) ideal for charging 70Ah 12v or larger batteries and providing solar energy for small lighting systems.

Peak output: 10W

Size: H: 350mm x W: 290mm



20W Solar Panel

[20W solar panel](#) ideal for charging 12v batteries or to provide enough power for a simple 4 light system in a shed or outbuilding.

Peak output: 20W

Size: H: 530mm x W: 360mm



30W Solar Panel

[30W solar panel](#) ideal for charging 12v batteries or to provide enough power for a 6 light system in a shed or outbuilding.

Peak output: 30W

Size: H: 540mm x W: 430mm



50W Solar Panel

[50W solar panel](#) is ideal for charging 70Ah or larger 12v batteries and providing solar energy for outbuilding power and lighting systems.

Peak output: 50W

Size: H: 680mm x W: 680mm

GEO MAINS FREE SOLAR LIGHTING KITS

Our Geo Mains Free Solar Lighting Kits provide light and power to locations without mains power or where cost-effective environmentally friendly power solutions are preferred.

Installing a mains power supply to remote locations isn't always possible and is often highly expensive when it is.

Geo Mains Free Solar Lighting Kits can be installed by anyone with basic DIY skills and are exempt from Part P of the building regulations which means there is no need to pay an electrician to have your kit installed or certified.

Comparison Chart

Product Name	GEO 1	GEO 2	GEO 3	GEO 4	GEO 5
Bulb(s) 3w (40watt equivalent)	1	2	4	6	10
Max Runtime (hours) *	48	68	75	69	42
Average Nightly Runtime (hours) **	6.5	6.5	6.5	6.5	6.5
Area Lit (Sq m)	16	32	48	60	82
Switch	Wall	Wall	Wall	Wall	Wall
Recommended Battery (Ah)	12	34	75	75	85
Cable provided (metres)	5	5	10	10	15
Solar Panel (watts)	5w	10w	20w	30w	50w
Installation time (minutes)	60	60	75	75	75
Price	£69.98	£99.98	£169.99	£249.98	£349.99

* based on fully charged battery

** based on 4 hrs charge

GEO 1 MAINS FREE SOLAR LIGHTING KIT

The **Geo 1** comes with a single 3W LED bulb suitable for lighting an area of up to 16 square metres making it ideal for medium sized rooms, sheds, garages, outhouses, Wendy houses, greenhouses and tree houses.

Kit includes:

- 1 x 5W solar panel
- 2 x crocodile clips
- 2 x fuse holders
- 2 x 5a fuse
- 6 x ring terminals
- 8 x cable clips
- 1 x light bulb holder
- 1 x light switch box
- 2 x connection blocks
- 4 x screws
- 4 x roof fixing blocks
- 1 x 5m run of cable
- 1 x 3W LED bulbs
- 4 x cable ties



GEO 1
SOLAR LIGHTING KIT™

Product Code: SS9048

Specifications

Solar Panel Size: **H: 250mm x W: 200mm**

Panel Wattage: **5W**

Boxed Weight: **2kg**

GEO 2 MAINS FREE SOLAR LIGHTING KIT

The **Geo 2** comes with two 3W LED bulbs suitable for lighting an area of up to 32 square metres making it ideal for medium / large sized rooms, sheds, garages, outhouses, Wendy houses and tree houses.

Kit includes:

- 1 x 10W solar panel
- 2 x crocodile clips
- 2 x fuse holders
- 2 x 5a fuse
- 6 x ring terminals
- 8 x cable clips
- 2 x light bulb holder
- 1 x light switch box
- 2 x connection blocks
- 4 x screws
- 4 x roof fixing blocks
- 1 x 5m run of cable
- 2 x 3W LED bulbs
- 4 x cable ties



GEO 2
SOLAR LIGHTING KIT™

Product Code: SS9049

Specifications

Solar Panel Size: **H: 350mm x W: 290mm**

Panel Wattage: **10W**

Boxed Weight: **3kg**

GEO 3 MAINS FREE SOLAR LIGHTING KIT

The **Geo 3** comes with four 3W LED bulbs suitable for lighting an area of up to 64 square metres making it ideal for large rooms, stables, sheds, garages and outhouses as well as providing power for a variety of small electronic devices.

Kit includes:

- 1 x 20W solar panel
- 2 x crocodile clips
- 2 x fuse holders
- 2 x 5a fuse
- 10 x ring terminals
- 4 x light bulb holder
- 1 x 4Ah Charge controller
- 1 x light switch box
- 2 x connection blocks
- 4 x screws
- 4 x roof fixing blocks
- 1 x 10m run of cable
- 4 x cable ties
- 4 x 3W LED bulbs

Specifications

Solar Panel Size:	H: 530mm x W: 360mm
Panel Wattage:	20W
Boxed Weight:	4.5kg



GEO 3
SOLAR LIGHTING KIT™

Product Code: SS9050

GEO 4 MAINS FREE SOLAR LIGHTING KIT

The **Geo 4** comes with six 3W LED bulbs suitable for lighting an area of up to 96 square metres making it ideal for small halls and warehouses, large sheds, stables, garages, and outhouses as well as providing power for a variety of small electronic devices.

Kit includes:

- 1 x 30W solar panel
- 2 x crocodile clips
- 2 x fuse holders
- 2 x 5a fuse
- 10 x ring terminals
- 6 x light bulb holder
- 1 x 4Ah Charge controller
- 1 x light switch box
- 2 x connection blocks
- 4 x screws
- 4 x roof fixing blocks
- 1 x 10m run of cable
- 4 x cable ties
- 6 x 3W LED bulbs

Specifications:

Solar Panel Size:	H: 540mm x W: 430mm
Panel Wattage:	30W
Boxed Weight:	6.5kg



GEO 4
SOLAR LIGHTING KIT™

Product Code: SS9051

GEO 5 MAINS FREE SOLAR LIGHTING KIT

The **Geo 5** comes with ten 3W LED bulbs suitable for lighting an area of up to 160 square metres making it ideal for small halls and warehouses, large sheds, stables, garages, and outhouses as well as providing power for a variety of small electronic devices.

Kit includes:

- 1 x 50W solar panel
- 2 x crocodile clips
- 2 x fuse holders
- 2 x 5a fuse
- 10 x ring terminals
- 10 x light bulb holder
- 1 x 4Ah Charge controller
- 1 x light switch box
- 2 x connection blocks
- 4 x screws
- 4 x roof fixing blocks
- 1 x 15m run of cable
- 4 x cable ties
- 10 x 3W LED Bulbs

Specifications:

Solar Panel Size:	H: 680mm x W: 680mm
Panel Wattage:	50W
Boxed Weight:	8.5kg



GEO 5
SOLAR PANELS & KITS™

Product Code: SS9051



The Solar Centre Ltd
Unit 5
Dencora Centre
Campfield Road
St Albans
AL1 5HN

tel. 01727 893 548
fax. 01727 260 004
trade@solarcentre.co.uk
www.solarcentre.co.uk

www.solarcentre.co.uk