

GRAFTON

SOLAR DOWN LIGHT

USER GUIDE



Ensure your solar panel is South facing or as near as possible



Clean your solar panel from time to time

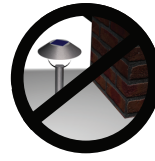

Do NOT place your solar panel in shaded areas.



Do NOT charge behind glass

Thank you for choosing the Grafton Solar Down Light. Please read these instructions carefully before using your light.

Important notes

Always take care when installing your light. If you are at all unsure, please contact your retailer or a professional trades person for advice.

Installation

Remove all packaging and put to one side. Please carefully consider where you wish to install your light before making alterations to your property. It's particularly important that the solar panel receives as much sunlight as possible. Ensure that it is not obstructed by buildings, fences, trees, sheds, etc. or the shadows that these create. **If the solar panel is installed in a poor location, it may not perform to the best of its ability.**

To maximise the battery capacity, the light should be charged in direct sunlight for a full day, where possible, before being used for the first time. Failure to do so can shorten the battery life or performance of the light.

The light will turn ON/OFF automatically when left in the on position. Please note it is completely normal for the light to come on at different times as it depends on how fast it charges in the location..

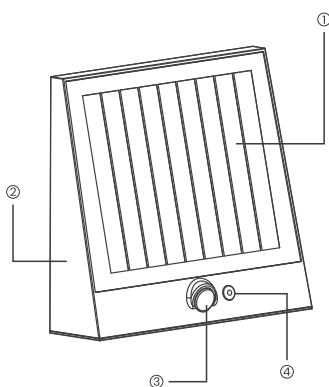

- ① Solar Panel
- ② Lamp Body
- ③ PIR
- ④ Switch Button

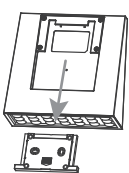

Step 1:
Remove the bracket from the lamp body and mark two holes using the bracket as a guide

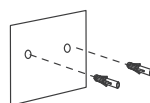

Step 2:
Using your guide, drill into the wall and secure the wall plugs into the wall

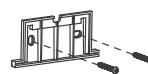

Step 3:
Fix the bracket onto the wall using the screws provided

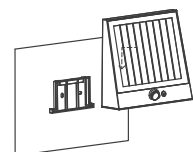

Step 4:
Hang the lamp body on the bracket and secure into place

How to use

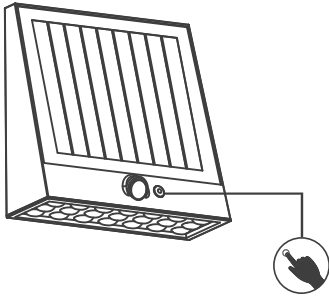

Step 1: To switch the light ON or OFF, press and hold the button for 1.5 seconds

Step 2: To change between the different lighting modes, this requires a short press only

Lighting Modes:

Mode 1: Light is at 25% brightness (250lm) until dawn

Mode 2: Light is at 10% brightness (100lm) + motion sensor for 30 seconds when activated

Mode 3: Light remains off until motion sensor is activated for 30 seconds until motion has stopped **[best for winter]**

Mode 4: Light is at full brightness (1000lm) until dawn

Troubleshooting

Please ensure that there are no nearby light sources shining on the solar panel after dark. These could be bright indoor/outdoor lights from your property or neighbours, or street lights.

If you are unsure, take the light inside and test it in a dark room indoors.

If you are encountering any problems with your light, often you can resolve this yourself by following our troubleshooting guide. If the light has its solar panel in a poor location it will struggle to work, but that doesn't mean there is a fault with the unit. Please remember that the light will arrive with some charge and will likely work for a few days even if the solar panel is poorly located. Please try the troubleshooting tips below before contacting your retailer:

Recharge Procedure

1. Double check the location of your solar panel to ensure it is in a clear location and as South facing as possible.
2. Turn the light off at the switch and leave it to recharge for 3-5 days ensuring one sunny day has passed.
3. After 3-5 days return to the light and turn it back on at the switch.
4. If your light still does not illuminate after dark, please contact your retailer.

Maintenance

Clean the surface of the solar panel and light lens with a soft, slightly moistened cloth. Do not use corrosive cleansing agents or chemical solutions as these may damage surfaces and impair operation. Keep the solar panel free of dirt, debris and snow.

Safety Instructions

The Solar Centre assumes no liability for any damage resulting from the use of this product, nor do we assume liability for any damage to property or personal injury caused by improper use or failure to observe these instructions.

Unauthorised conversion and/or modification of the unit may be dangerous and will invalidate your warranty. To avoid damage to sight, do not look directly at the light source. This device is not a toy and should be kept out of reach of children. Do not submerge the device in water or expose it to extreme temperatures (less than -25°C or higher than 50°C).

GRAFTON SOLAR DOWN LIGHT

MODEL NUMBER: SC2348

SOLARCENTRE®
44-46 COLDHARBOUR LANE
HARPENDEN
HERTFORDSHIRE
AL5 4UN

WWW.SOLARCENTRE.CO.UK

